

General Purpose NPN Epitaxial Planar Transistor

BTC3906M3

Description

The BTC3906M3 is designed for general purpose applications requiring high breakdown voltage.

Features

- High collector-emitter breakdown voltage. ($BV_{CEO}=160V @ I_C=1mA$)
- Complement to BTA1514M3
- Pb-free package

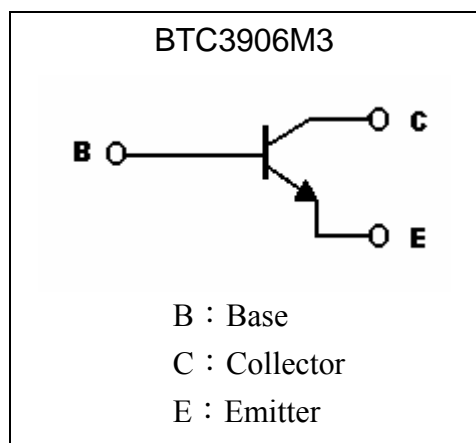
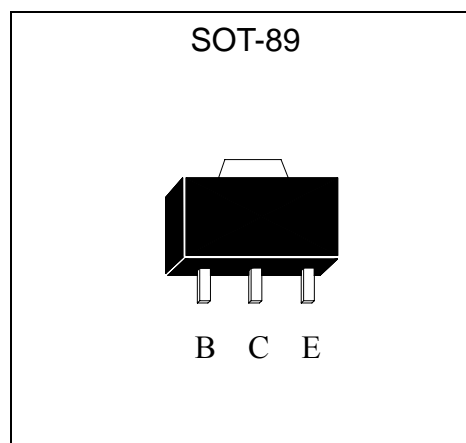
Symbol

Outline

Absolute Maximum Ratings ($T_a=25^{\circ}C$)

Parameter	Symbol	Limits	Unit
Collector-Base Voltage	V_{CBO}	180	V
Collector-Emitter Voltage	V_{CEO}	160	V
Emitter-Base Voltage	V_{EBO}	6	V
Collector Current	I_C	600	mA
Power Dissipation	P_d	0.6	W
		1 (Note 1)	W
		2 (Note 2)	W
Junction Temperature	T_j	150	$^{\circ}C$
Storage Temperature	T_{stg}	-55~+150	$^{\circ}C$

Note : 1. When mounted on FR-4 PCB with area measuring $10 \times 10 \times 1$ mm

2 . When mounted on ceramic with area measuring $40 \times 40 \times 1$ mm

**Characteristics (Ta=25°C)**

Symbol	Min.	Typ.	Max.	Unit	Test Conditions
BV _{CBO}	180	-	-	V	I _C =100μA
BV _{CEO}	160	-	-	V	I _C =1mA
BV _{EBO}	6	-	-	V	I _E =10μA
I _{CBO}	-	-	50	nA	V _{CB} =120V
I _{EBO}	-	-	50	nA	V _{EB} =4V
*V _{CE(sat)1}	-	0.1	0.15	V	I _C =10mA, I _B =1mA
*V _{CE(sat)2}	-	-	0.2	V	I _C =50mA, I _B =5mA
*V _{BE(sat)1}	-	-	1	V	I _C =10mA, I _B =1mA
*V _{BE(sat)2}	-	-	1	V	I _C =50mA, I _B =5mA
*h _{FE1}	50	-	-	-	V _{CE} =5V, I _C =1mA
*h _{FE2}	60	-	-	-	V _{CE} =5V, I _C =10mA
*h _{FE3}	50	-	-	-	V _{CE} =5V, I _C =50mA
*h _{FE4}	120	-	390	-	V _{CE} =6V, I _C =2mA
f _T	100	-	-	MHz	V _{CE} =20V, I _C =10mA, f=100MHz
Cob	-	-	6	pF	V _{CB} =20V, I _E =0A, f=1MHz

*Pulse Test: Pulse Width ≤380μs, Duty Cycle≤2%

Classification Of h_{FE} 4

Rank	Q	R
Range	120~270	180~390

Ordering Information

Device	Package	Shipping	Marking
BTC3906M3	SOT-89 (Pb-free)	1000 pcs / Tape & Reel	G1



Characteristic Curves

Current Gain vs Collector Current

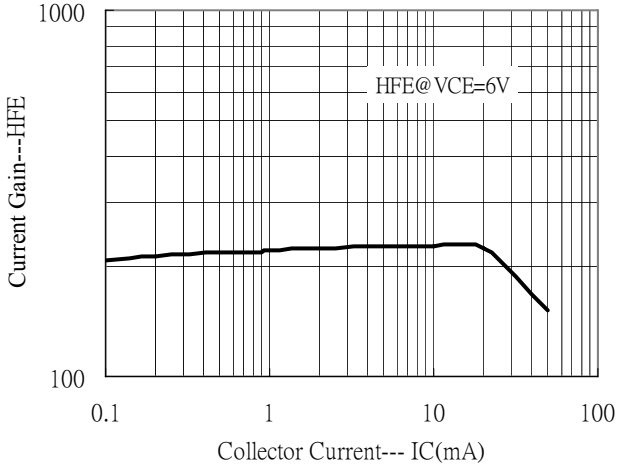

Saturation Voltage vs Collector Current

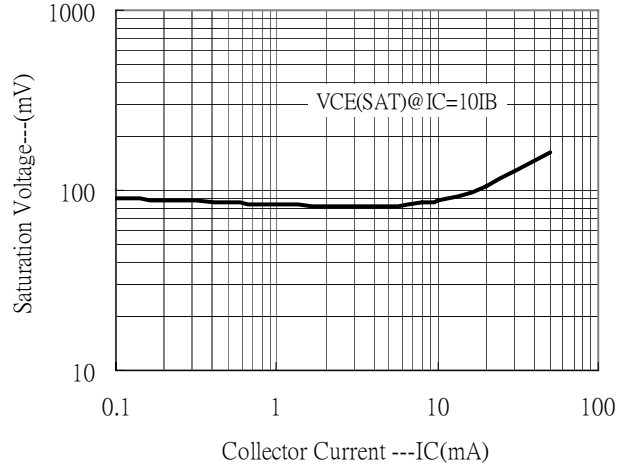

Saturation Voltage vs Collector Current

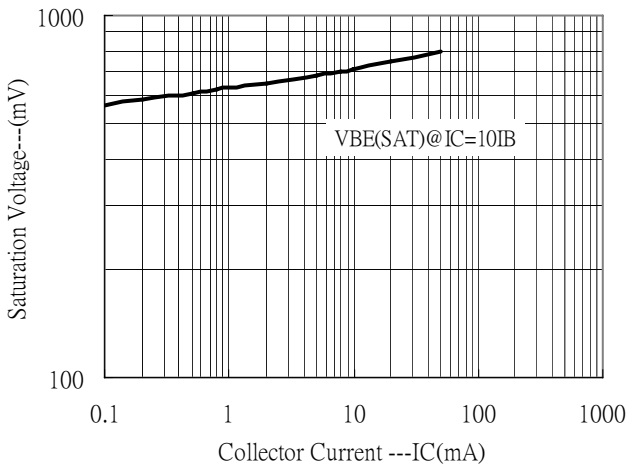

Cutoff Frequency vs Collector Current

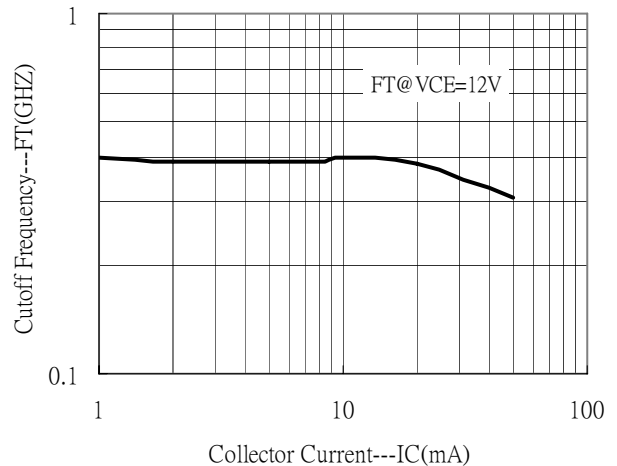

Power Derating Curves

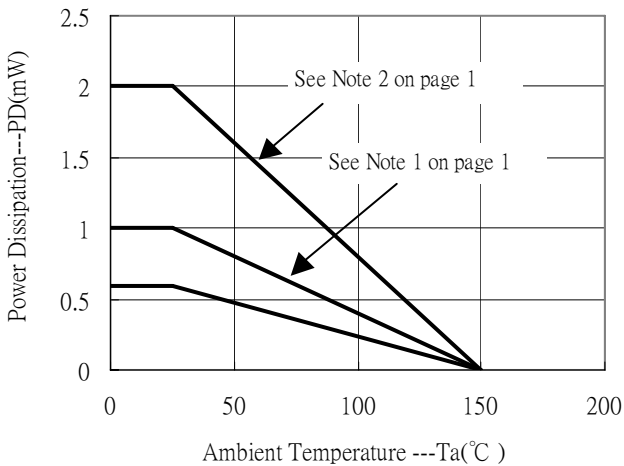

SOT-89 Dimension

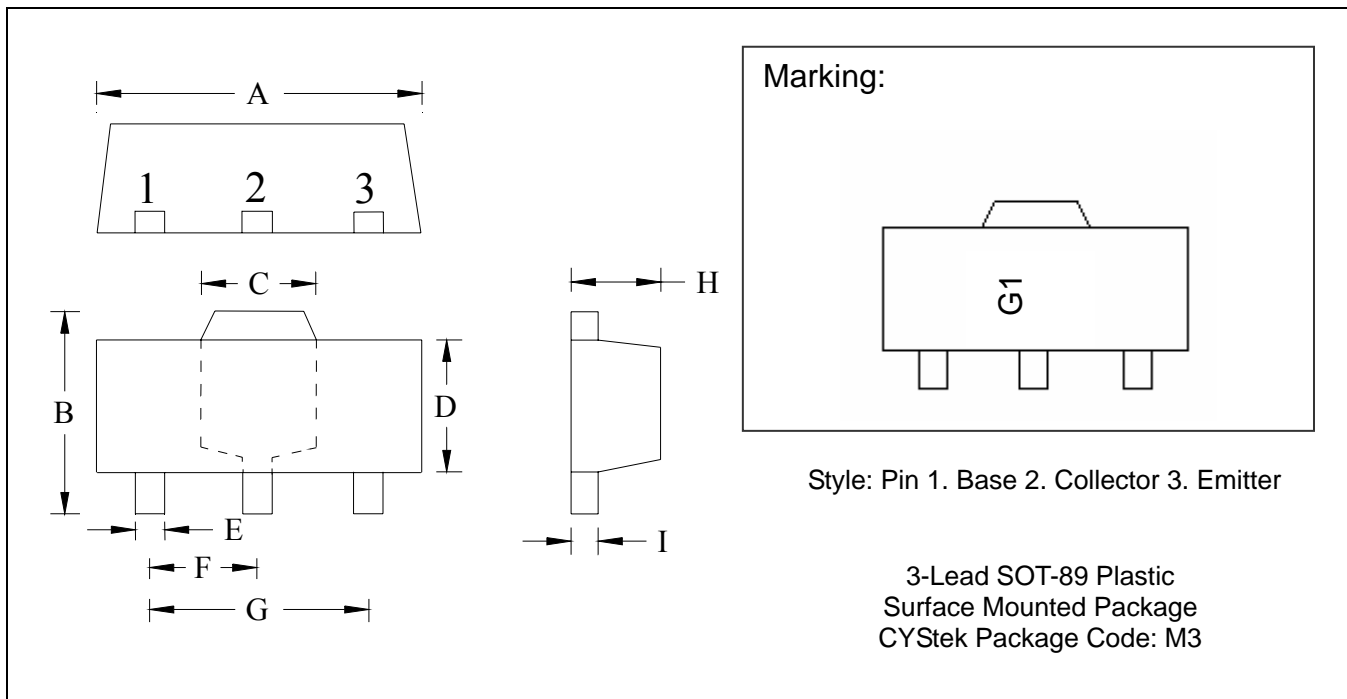

*: Typical

DIM	Inches		Millimeters		DIM	Inches		Millimeters	
	Min.	Max.	Min.	Max.		Min.	Max.	Min.	Max.
A	0.1732	0.1811	4.40	4.60	F	0.0583	0.0598	1.48	1.527
B	0.1594	0.1673	4.05	4.25	G	0.1165	0.1197	2.96	3.04
C	0.0591	0.0663	1.50	1.70	H	0.0551	0.0630	1.40	1.60
D	0.0945	0.1024	2.40	2.60	I	0.0138	0.0161	0.35	0.41
E	0.01417	0.0201	0.36	0.51					

Notes: 1.Controlling dimension: millimeters.
 2.Maximum lead thickness includes lead finish thickness, and minimum lead thickness is the minimum thickness of base material.
 3.If there is any question with packing specification or packing method, please contact your local CYStek sales office.

Material:

- Lead: 42 Alloy ; solder plating
- Mold Compound: Epoxy resin family, flammability solid burning class: UL94V-0

Important Notice:

- All rights are reserved. Reproduction in whole or in part is prohibited without the prior written approval of CYStek.
- CYStek reserves the right to make changes to its products without notice.
- CYStek **semiconductor products are not warranted to be suitable for use in Life-Support Applications, or systems.**
- CYStek assumes no liability for any consequence of customer product design, infringement of patents, or application assistance.